

ÖZEL AMAÇLI PROFİLLER
SPECIAL PROFILES



alüminyum

ÖZEL AMAÇLI PROFİLLER / SPECIAL PROFILES

MERDİVEN PROFİLLERİ
QUALITY IS NOT A COINCIDENCE

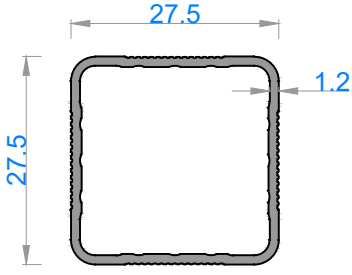

Sistem Kodu 319
Ağırlık (kg/mt) 0,337

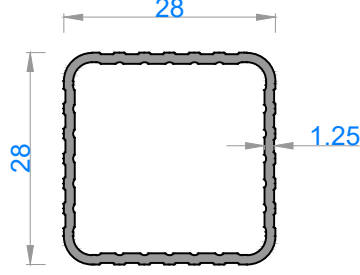

Sistem Kodu 750
Ağırlık (kg/mt) 0,353

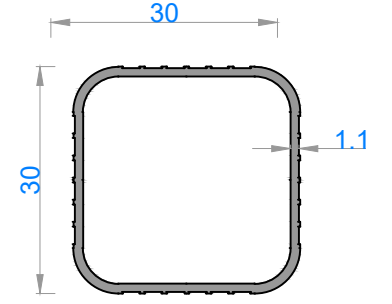

Sistem Kodu 11035
Ağırlık (kg/mt) 0,342

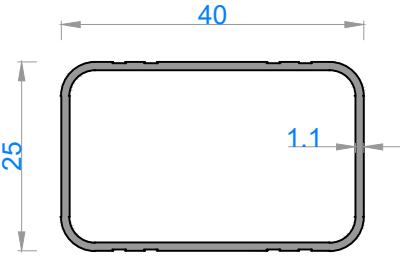

Sistem Kodu 752
Ağırlık (kg/mt) 0,347

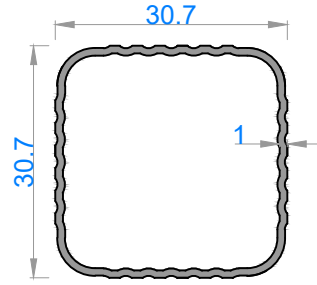

Sistem Kodu 5083
Ağırlık (kg/mt) 0,304

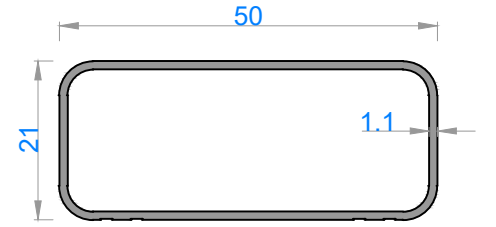

Sistem Kodu 11032
Ağırlık (kg/mt) 0,388

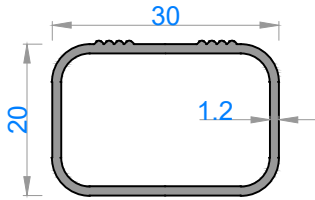

Sistem Kodu 13760
Ağırlık (kg/mt) 0,290

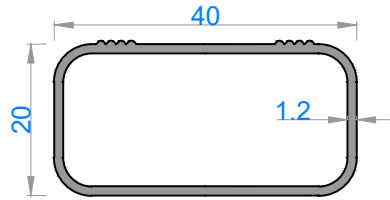

Sistem Kodu 13761
Ağırlık (kg/mt) 0,356

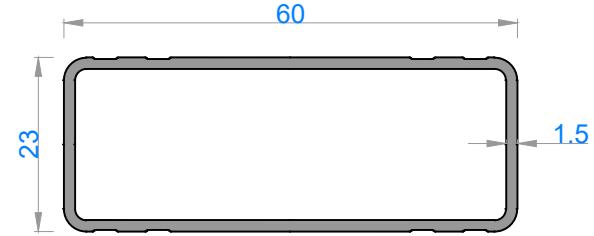

Sistem Kodu 11036
Ağırlık (kg/mt) 0,622

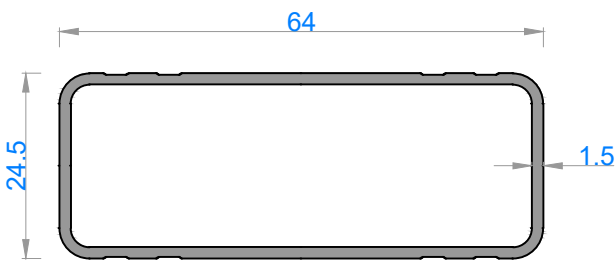

Sistem Kodu 11037
Ağırlık (kg/mt) 0,659

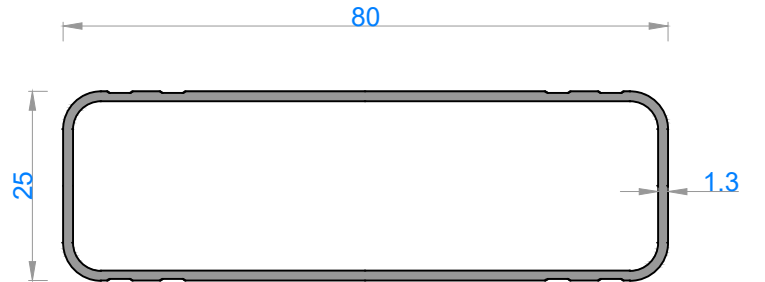

Sistem Kodu 11034
Ağırlık (kg/mt) 0,682

NOT: Profil ağırlıkları teoriktir, üretim sonrası ağırlıklar geçerlidir.



alüminyum

ÖZEL AMAÇLI PROFİLLER / SPECIAL PROFILES

MERDİVEN PROFİLLERİ

QUALITY IS NOT A COINCIDENCE

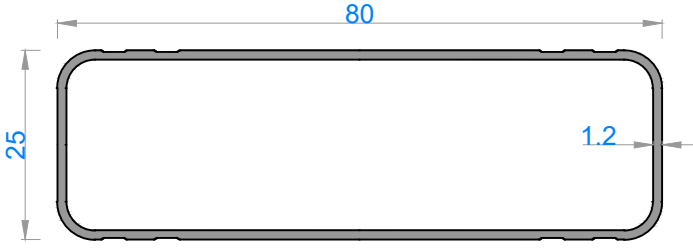

Sistem Kodu 10089
Ağırlık (kg/mt) 0,627

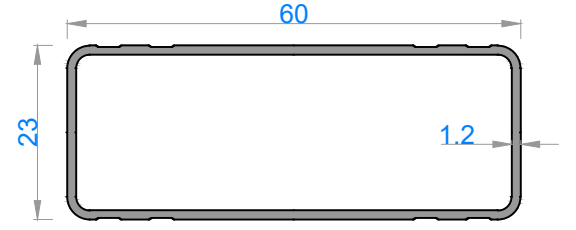

Sistem Kodu 10090
Ağırlık (kg/mt) 0,496

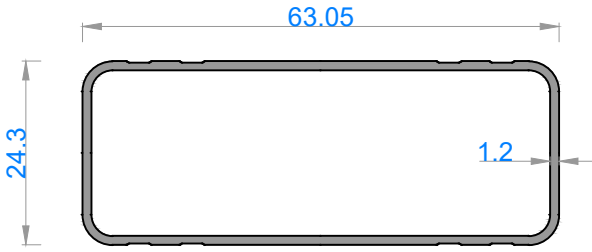

Sistem Kodu 10091
Ağırlık (kg/mt) 0,518

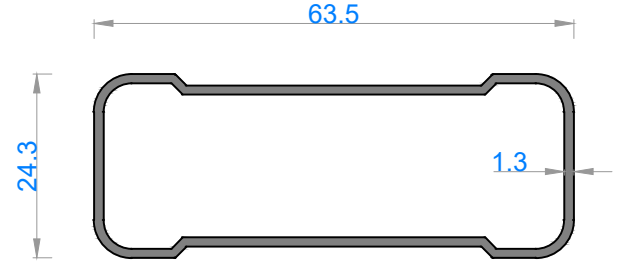

Sistem Kodu 13765
Ağırlık (kg/mt) 0,545

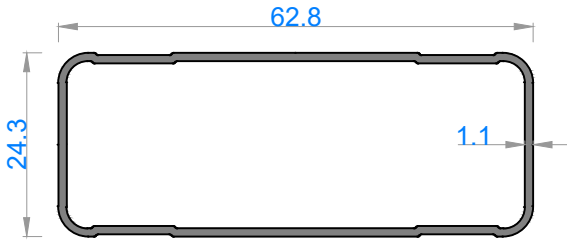

Sistem Kodu 10134
Ağırlık (kg/mt) 0,488

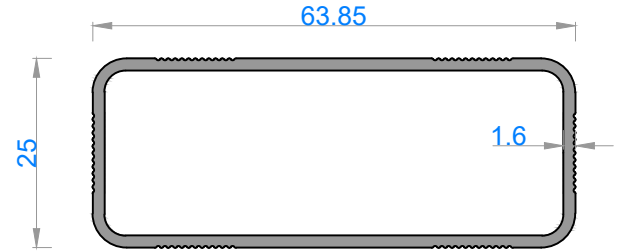

Sistem Kodu 10135
Ağırlık (kg/mt) 0,694

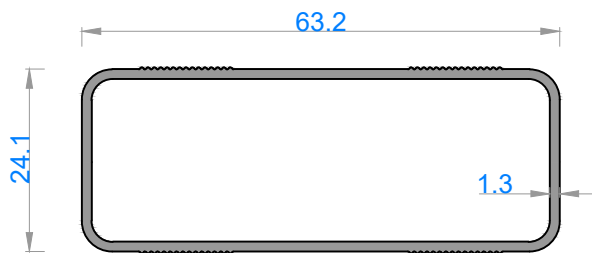

Sistem Kodu 10136
Ağırlık (kg/mt) 0,593

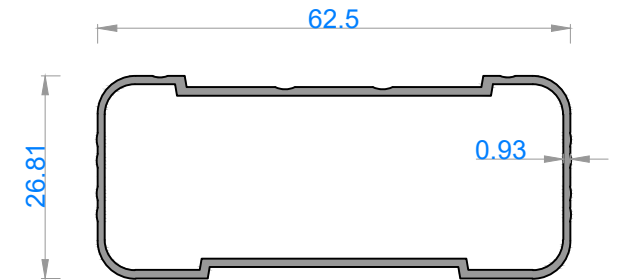

Sistem Kodu 10137
Ağırlık (kg/mt) 0,499

NOT: Profil ağırlıkları teoriktir, üretim sonrası ağırlıklar geçerlidir.



alüminyum

ÖZEL AMAÇLI PROFİLLER / SPECIAL PROFILES

MERDİVEN PROFİLLERİ

QUALITY IS NOT A COINCIDENCE

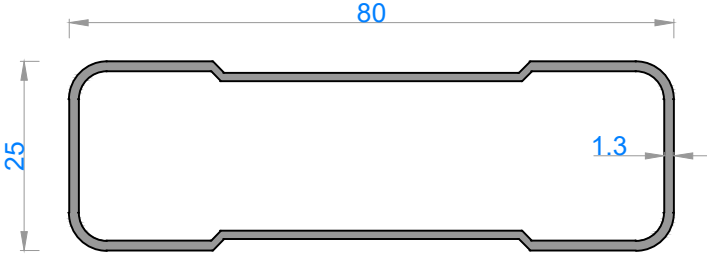

Sistem Kodu 13767
Ağırlık (kg/mt) 0,650

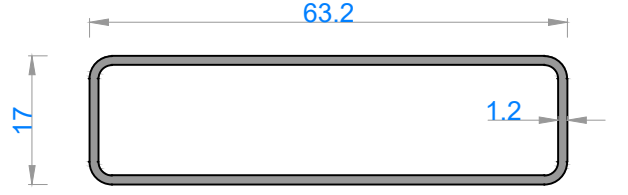

Sistem Kodu 5043
Ağırlık (kg/mt) 0,493

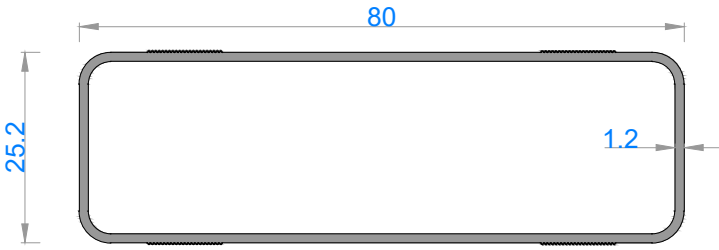

Sistem Kodu 5045
Ağırlık (kg/mt) 0,659

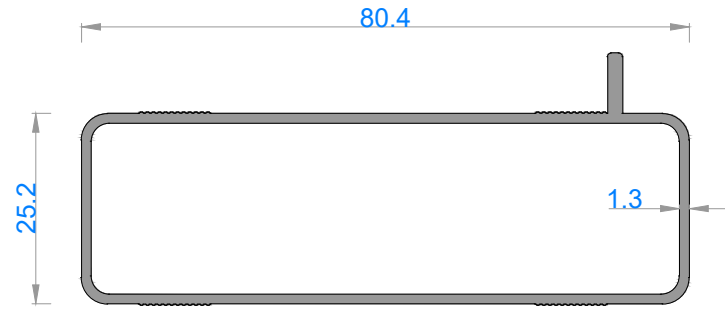

Sistem Kodu 5079
Ağırlık (kg/mt) 0,764

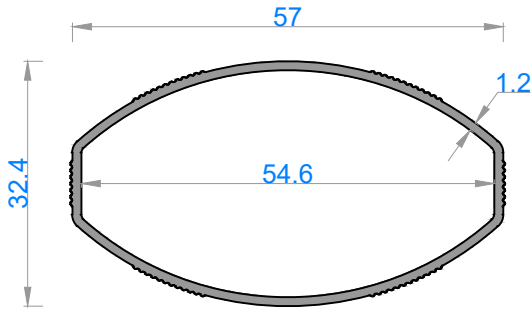

Sistem Kodu 10089
Ağırlık (kg/mt) 0,627

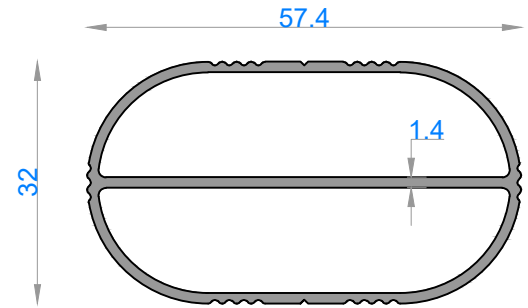

Sistem Kodu 751
Ağırlık (kg/mt) 0,742

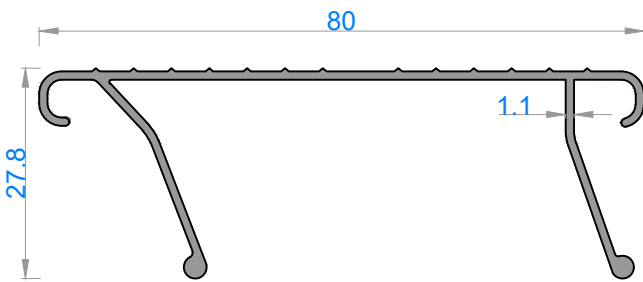

Sistem Kodu 11031
Ağırlık (kg/mt) 0,478

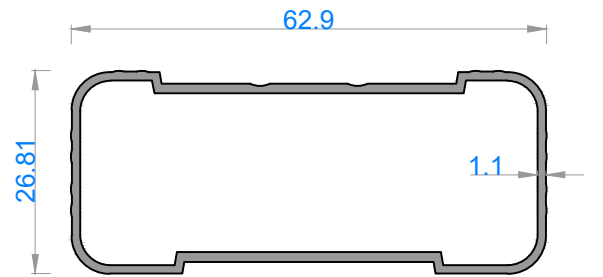

Sistem Kodu 11050
Ağırlık (kg/mt) 0,559

NOT: Profil ağırlıkları teoriktir, üretim sonrası ağırlıklar geçerlidir.



alüminyum

ÖZEL AMAÇLI PROFİLLER / SPECIAL PROFILES

MERDİVEN PROFİLLERİ

QUALITY IS NOT A COINCIDENCE

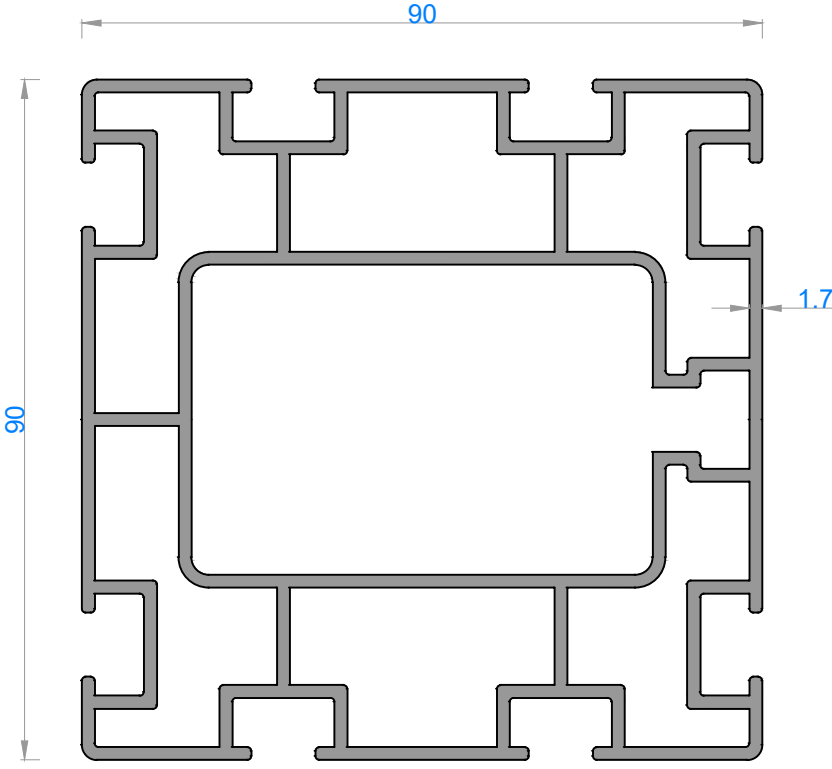

Sistem Kodu 13762

Ağırlık (kg/mt) 3,720

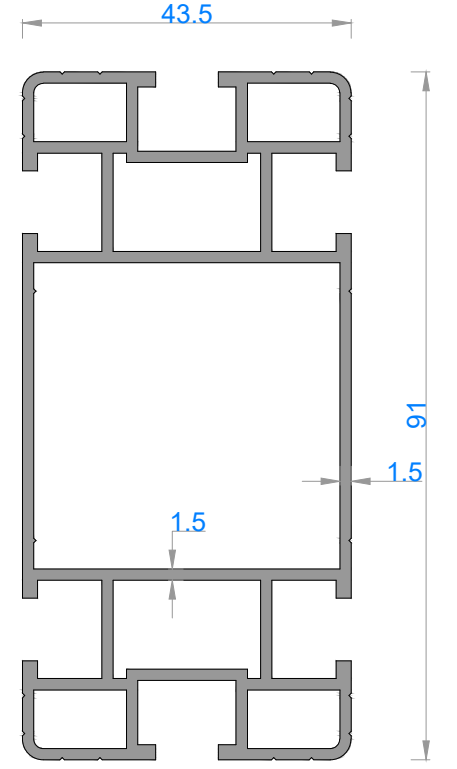

Sistem Kodu 5086

Ağırlık (kg/mt) 1,906

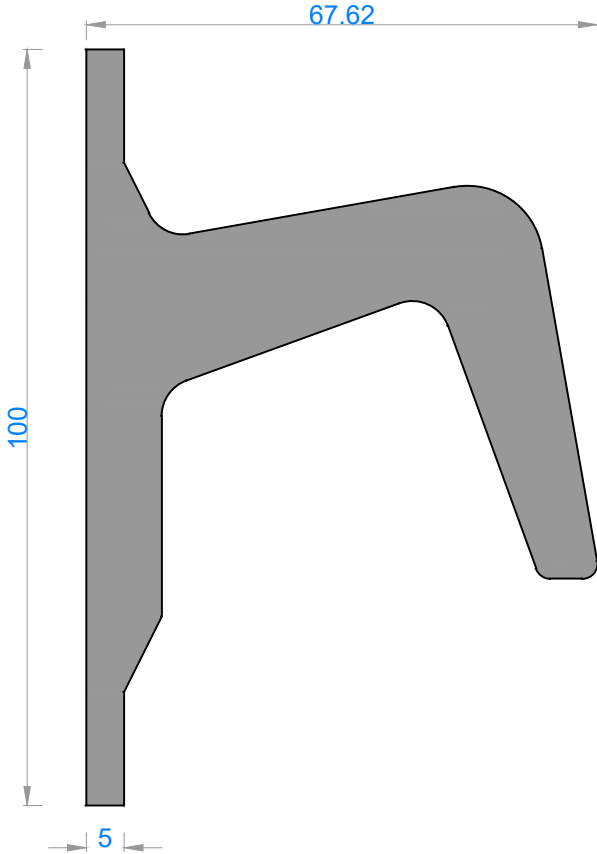

Sistem Kodu 5044

Ağırlık (kg/mt) 5,495

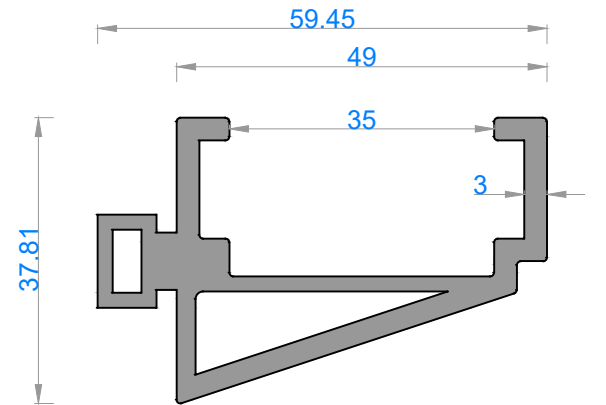

Sistem Kodu 5142

Ağırlık (kg/mt) 1,390

NOT: Profil ağırlıkları teoriktir, üretim sonrası ağırlıklar geçerlidir.



alüminyum

ÖZEL AMAÇLI PROFİLLER / SPECIAL PROFILES

MERDİVEN PROFİLLERİ

QUALITY IS NOT A COINCIDENCE

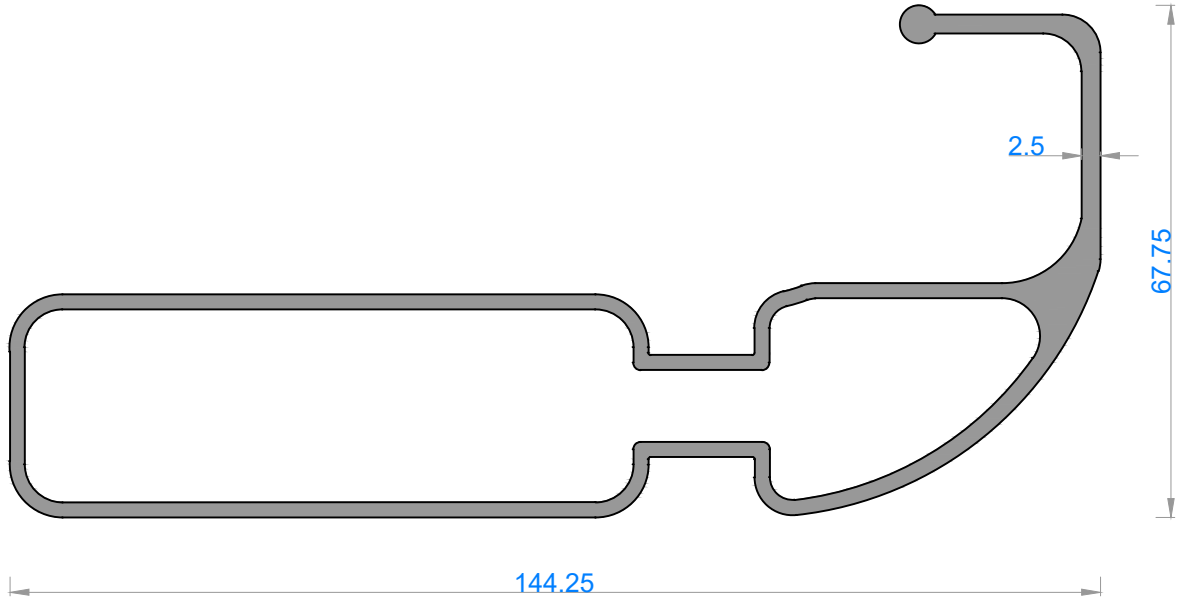

Sistem Kodu 13766
Ağırlık (kg/mt) 2,400

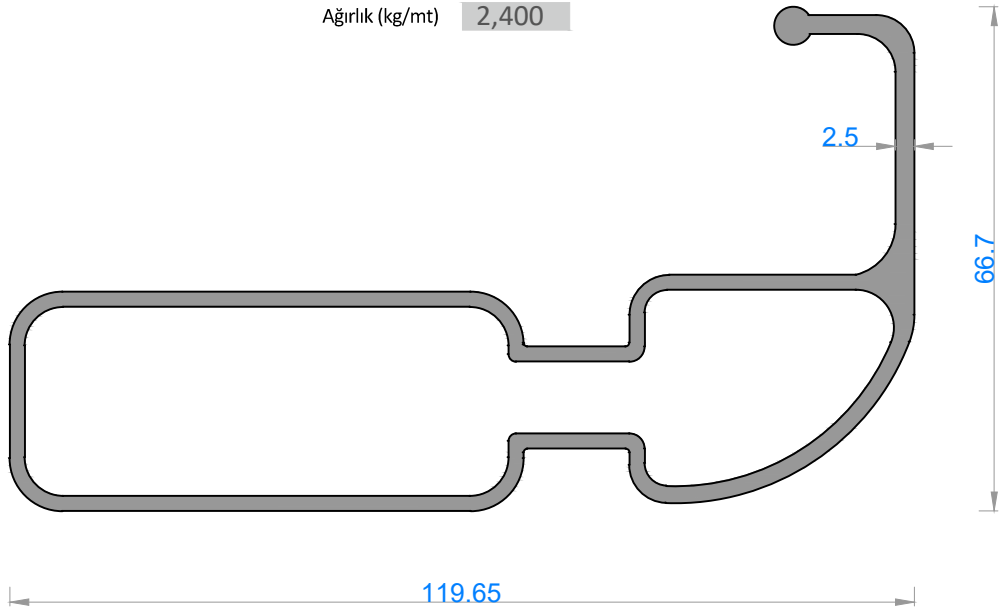

Sistem Kodu 13764
Ağırlık (kg/mt) 2,030

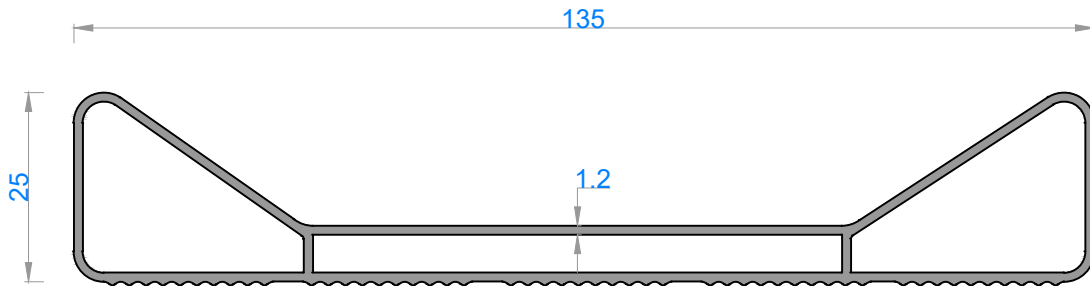

Sistem Kodu 5129
Ağırlık (kg/mt) 1,141

NOT: Profil ağırlıkları teoriktir, üretim sonrası ağırlıklar geçerlidir.

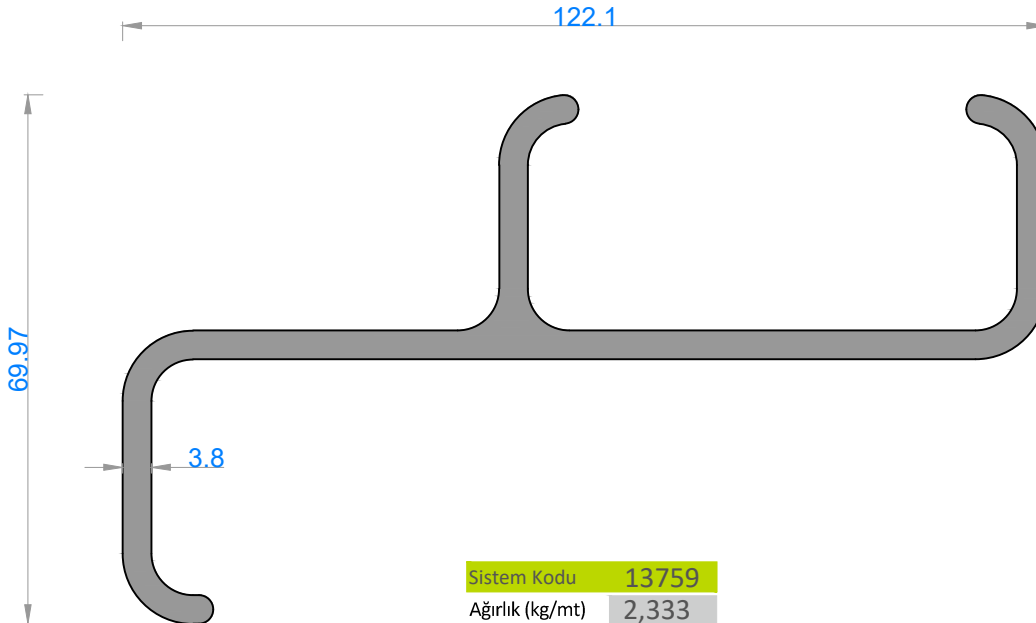
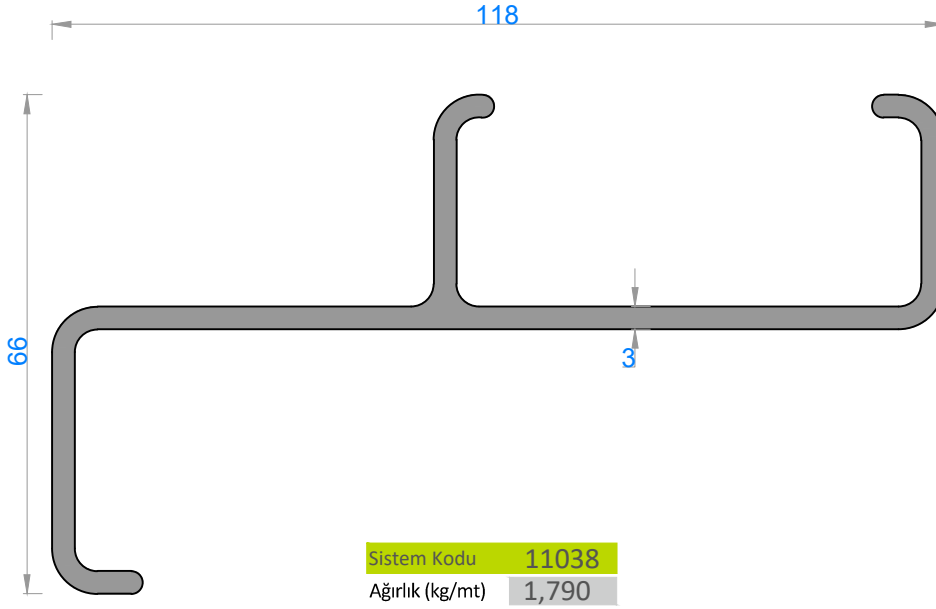
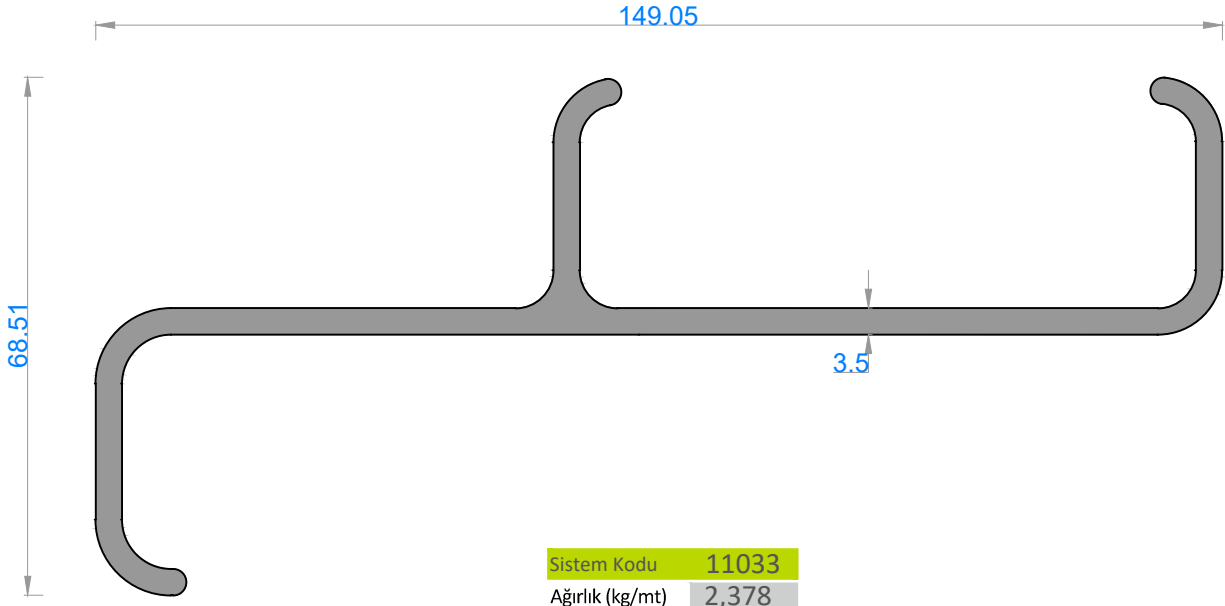

NOT: Profil ağırlıkları teoriktir, üretim sonrası ağırlıklar geçerlidir.